

0 611 213 703

Issue } 06-10-25
Stand }

Fig./Abb. 2

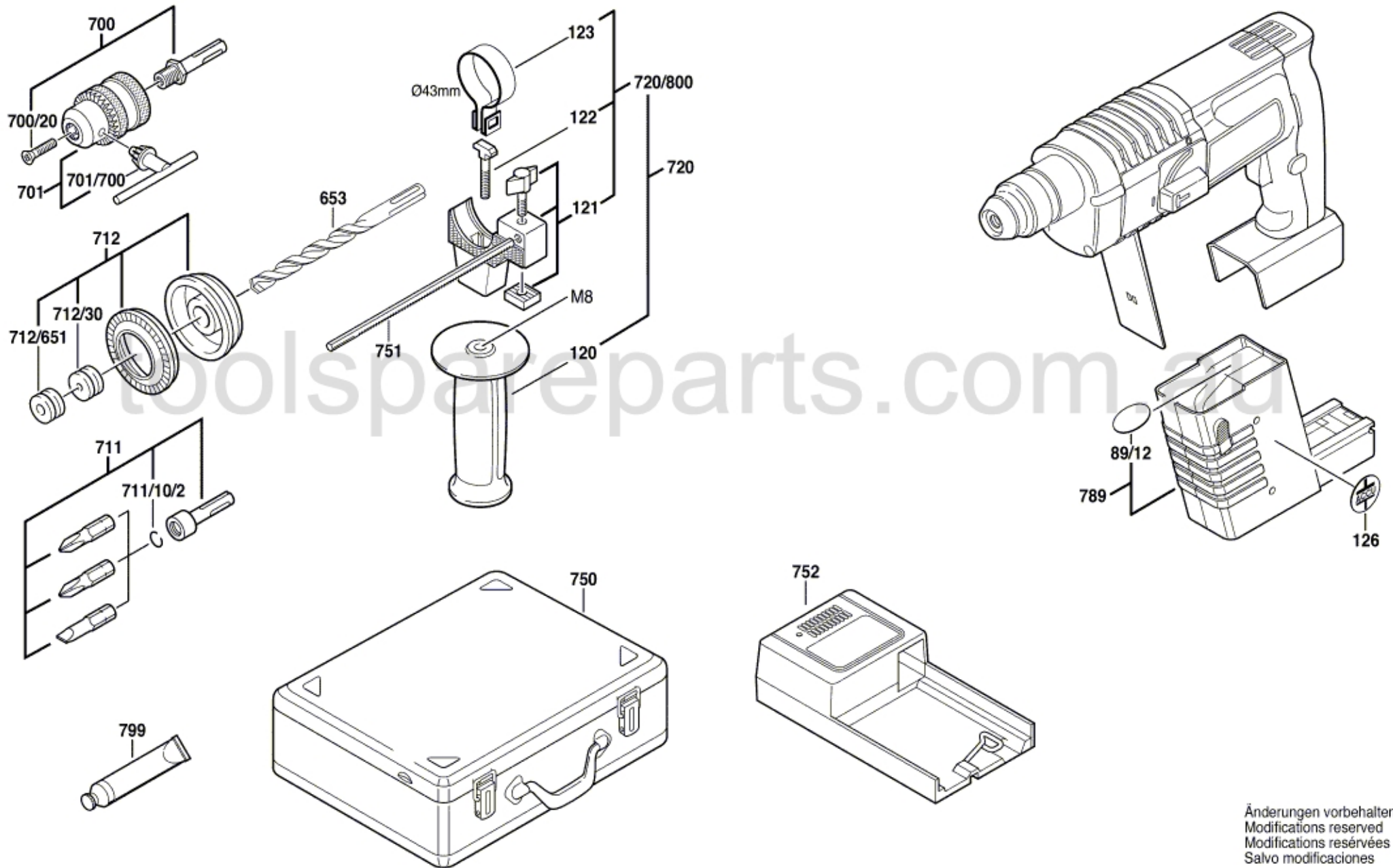

Änderungen vorbehalten
Modifications reserved
Modifications réservées
Salvo modificaciones